

3.ST16.001

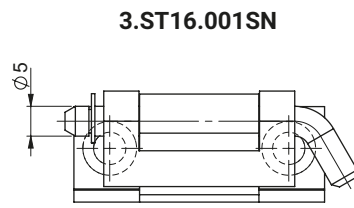

3.ST16.001SN

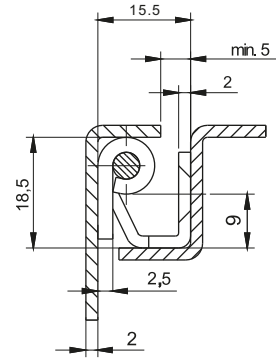

CATALOGUE NO.	COMPONENTS	MATERIAL
3.ST16.001	Base, Pin	Steel zinc plated
	Holder	Steel
3.ST16.001SN	Holder, Base, Pin	Stainless steel

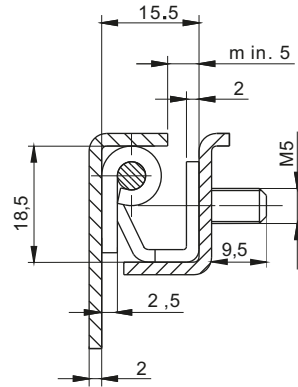
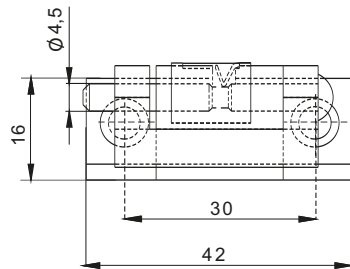
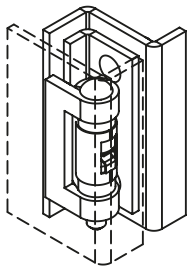

CATALOGUE NO.	COMPONENTS	MATERIAL
3.ST16.004	Holder	Steel
	Base, Pin	Steel zinc plated
	Spring	Stainless steel

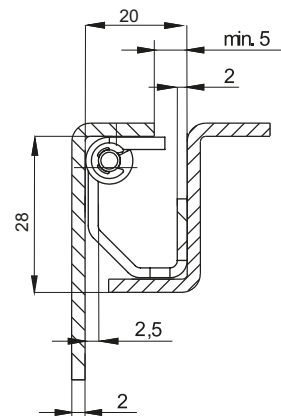
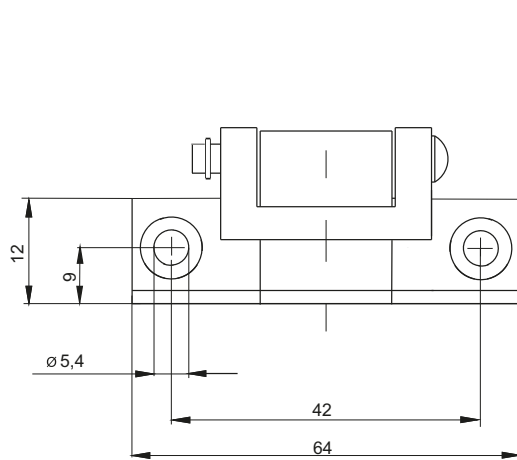

CATALOGUE NO.	COMPONENTS	MATERIAL
3.ST16.006	Base, Pin	Steel zinc plated
	Holder	Steel