

CAT. NUMBER	NAME	MATERIAL
4.411.001	Tommy screw	Polyamide-PA6 GF30 RAL/Steel zinc plated

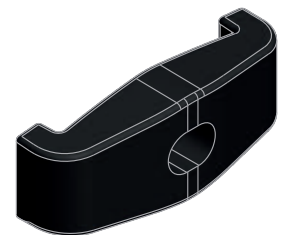

Bridge clamp 56
4.411.003

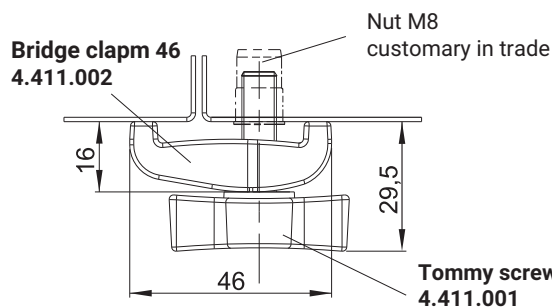
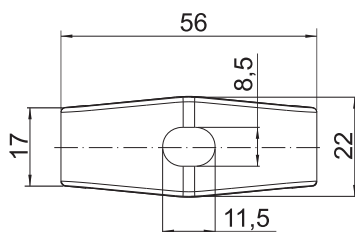

Bridge clamp 80
4.411.004

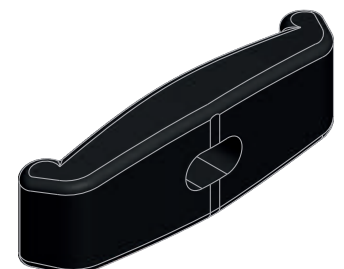
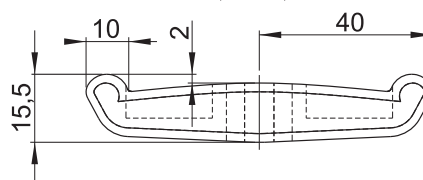
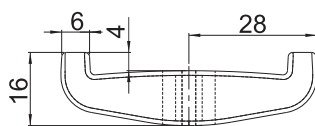
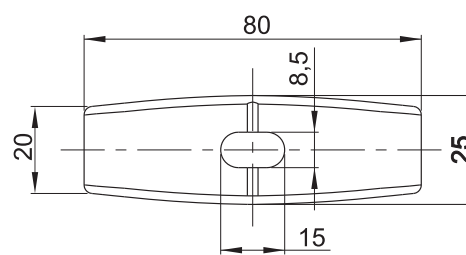

CAT. NUMBER	NAME	MATERIAL
4.411.002	Bridge clamp 46	Polyamide PA6 Gf30
4.411.003	Bridge clamp 56	
4.411.004	Bridge clamp 80	