

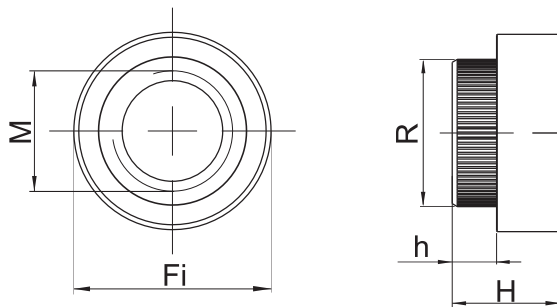

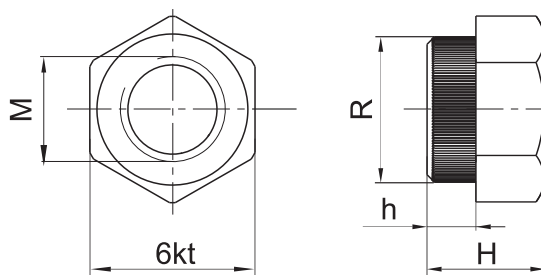



ROUND NUT



HEXAGONAL NUT



| SHAPE | DIMENSIONS | | | | | | MATERIAL | CAT. NUMBER |
|---|------------|----|-----|------|------|-----|---------------------|-----------------|
| | M | Fi | 6kt | Fi R | H | h | | |
|  | 12 | 20 | | 14,9 | 11 | 4,5 | Steel - zinc plated | NR.01.00 |
|  | 12 | 20 | | 14,9 | 10,5 | 4 | Steel - zinc plated | NR.01.02 |
|  | 12 | 19 | | 15 | 11 | 4 | Steel - zinc plated | NR.01.03 |
|  | 10 | 18 | | 13 | 11 | 4,5 | Steel - zinc plated | NR.03.01 |
|  | 8 | 15 | | 10,8 | 9,5 | 4,5 | Steel - zinc plated | NR.02.01 |
|  | 6 | 12 | | 8,5 | 6,8 | 2,8 | Steel - zinc plated | NR.04.01 |
|  | 5 | 10 | | 7,5 | 6,8 | 2,8 | Steel - zinc plated | NR.05.01 |
|  | 12 | | 19 | 14,8 | 12 | 4,5 | Steel - zinc plated | NR.01.04 |
|  | 10 | | 17 | 12,9 | 11 | 4,5 | Steel - zinc plated | NR.03.02 |
|  | 8 | | 13 | 10,7 | 9,5 | 4,5 | Steel - zinc plated | NR.02.02 |