

Wersja
3.ZN70.001
3.ZN70.002

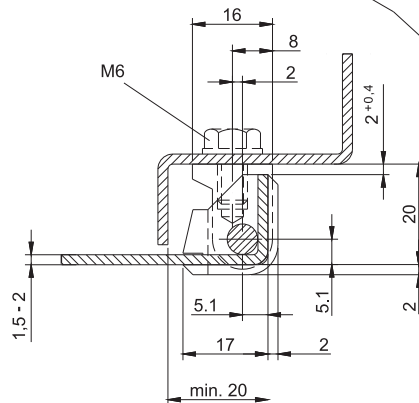

Wersja
3.ZN70.003

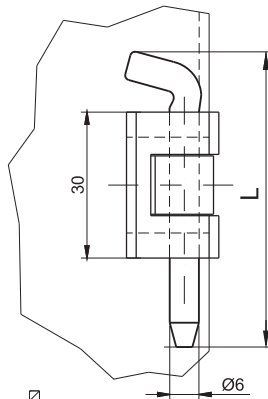
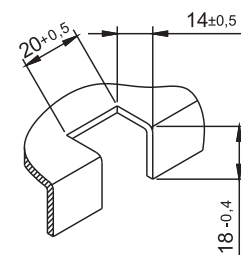
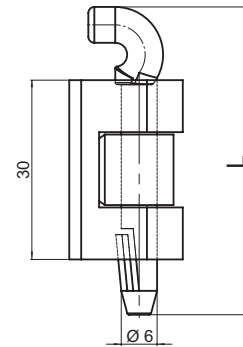

Otwór montażowy

NUMER KATALOGOWY	WYMIAR L [mm]		ELEMENTY SKŁADOWE	MATERIAŁ	WYKOŃCZENIE [C]				
					Chrom	Nikiel	RAL9005	RAL7035	RAL7032
3.ZN70.001	56,5	70	Uchwyt, Stopa	ZAMAK 5	01	02	04	05	12
			Sworzeń	Stal ocynkowana					
3.ZN70.003	51,5		Uchwyt, Stopa	ZAMAK 5					
			Sworzeń	POM					
3.ZN70.002SN	56,5	70	Uchwyt, Stopa, Sworzeń	Stal nierdzewna					

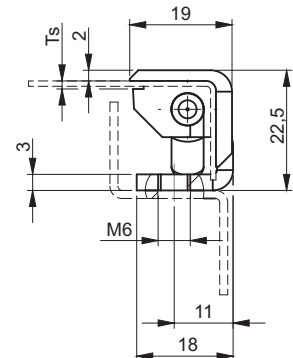
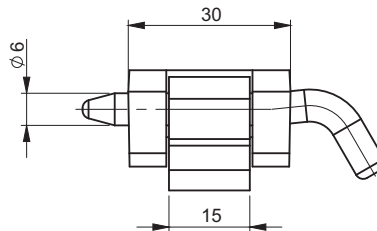
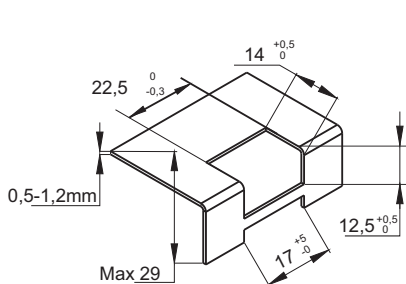

Ts - grubość blachy montażowej [mm]

NUMER KATALOGOWY	Ts [mm]	ELEMENTY SKŁADOWE	MATERIAŁ	WYKOŃCZENIE [C]			
				Chrom	Nikiel	RAL9005	RAL7035
3.ZN75.003	0,8-1,2	Uchwyt, Stopa	ZAMAK 5	01	02	04	05
		Sworzeń	Stal ocynkowana				
3.ZN75.004	1,5-2,0	Uchwyt, Stopa	ZAMAK 5				
		Sworzeń	Stal ocynkowana				

Jak zamawiać :

Nr katalogowy

Wymiar L

Wykończenie

